

III. REMARKS ON DISASSEMBLING AND REASSEMBLING

● Hands

• Caution for disassembling

The hour wheel is made of engineering plastics. When pulling out the hour hand, take care not to damage the hour wheel.

• How to install

1) Pull out the crown with winding stem to the second click. Then, turn the crown clockwise to turn the time hands also clockwise.

2) Stop turning the crown when the date changes to the next.

3) 7T62: Install the stopwatch minute hand, alarm hour and minute hands so that they point exactly to the 12 o'clock position.

7T92: Install the stopwatch 1/20-second hand, stopwatch hour and minute hands so that they point exactly to the "0" position.

7T94: Install stopwatch minute hand so that it points exactly to the "0" position.

4) Install the small second, hour and minute hands so that they point exactly to the 12 o'clock position.

5) Install the stopwatch hand so that it points exactly to the "0" position of the stopwatch scale.

* After installing the hands, be sure to check that they move smoothly without interfering with one another.

● Dial

• Caution for disassembling

When disassembling the dial, take care not to bend the dial leg. Raise the portions around the dial legs by turns gradually to remove the dial.

① Pin for date dial guard

• How to remove

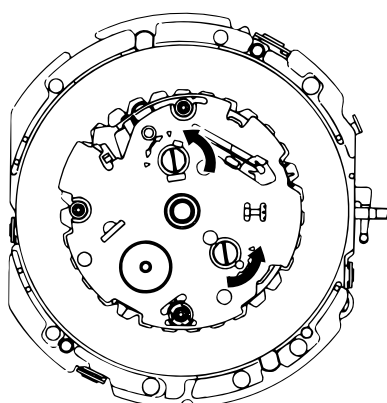

1. Turn the pin 90-degree counterclockwise to loosen the pin using a screwdriver.
2. Pick up the pin using rodico.

• How to install

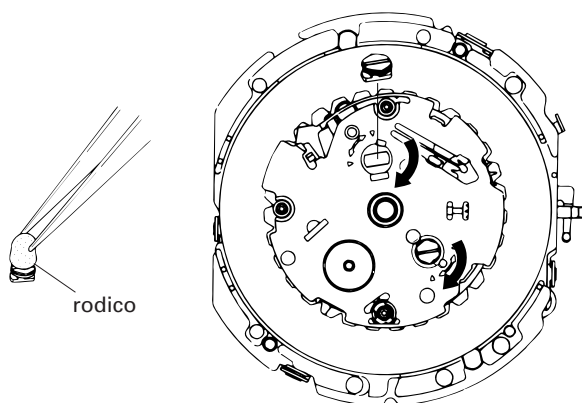

1. Set the pin securely into the groove.
2. Turn the pin 90-degree clockwise to fix the pin using a screwdriver.

Notes:

- * Do not turn the pin more than 90-degree in either direction. Take care so as not to break the plastic parts.
- * Do not turn the pin forcibly.
- * Use a screwdriver of an appropriate size .

- **Lubricating**

After installing the pins for date dial guard, lubricate the wheel edge of both the date driving wheel and date dial.

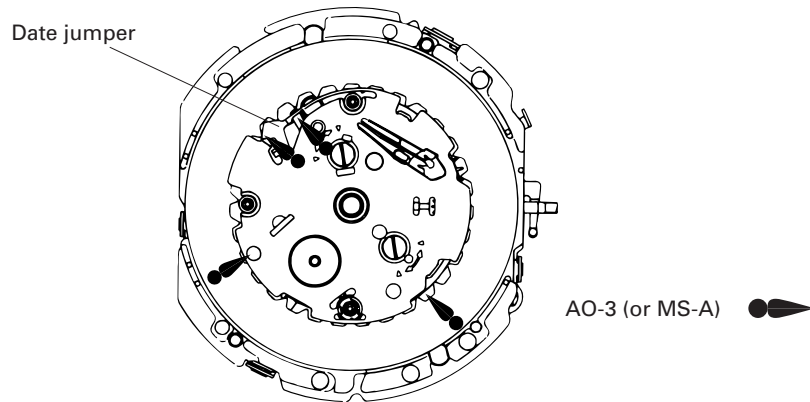

⑧ Hour wheel

When installing the hour wheel, check that it engages with the pinion of the minute wheel.

⑩ Battery clamp

When installing the battery clamp, set it securely to the two hooking portions of the movement.

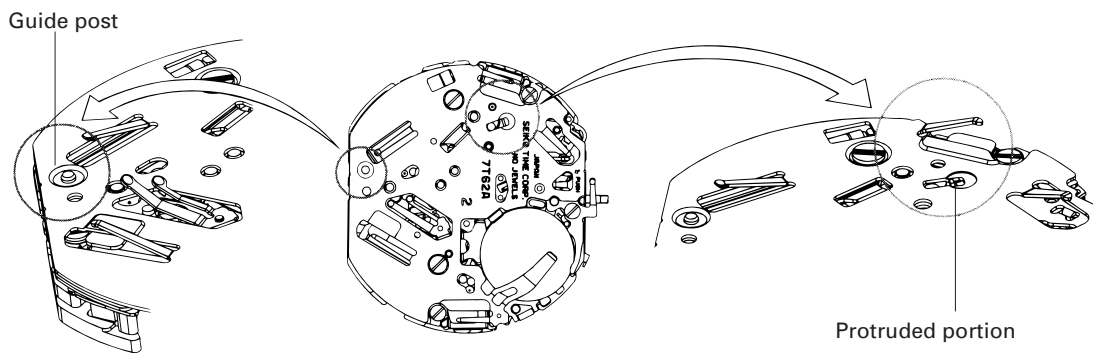

⑬ Circuit block cover

• **How to remove**

- 1) Loosen the four circuit block cover screws.
- 2) Release the four hooking portions of the circuit block cover (indicated by the arrows in the illustration below.)

• **How to install**

- 1) Have the four hooking portions of the circuit block cover (indicated by the arrows in the illustration below) catch the movement securely. In doing so, check if the circuit block is set properly to guide posts "a" and "b", and reset it in position if necessary.
- 2) Tighten the four circuit block cover screws. When tightening the screws, take care not to cut the coil.

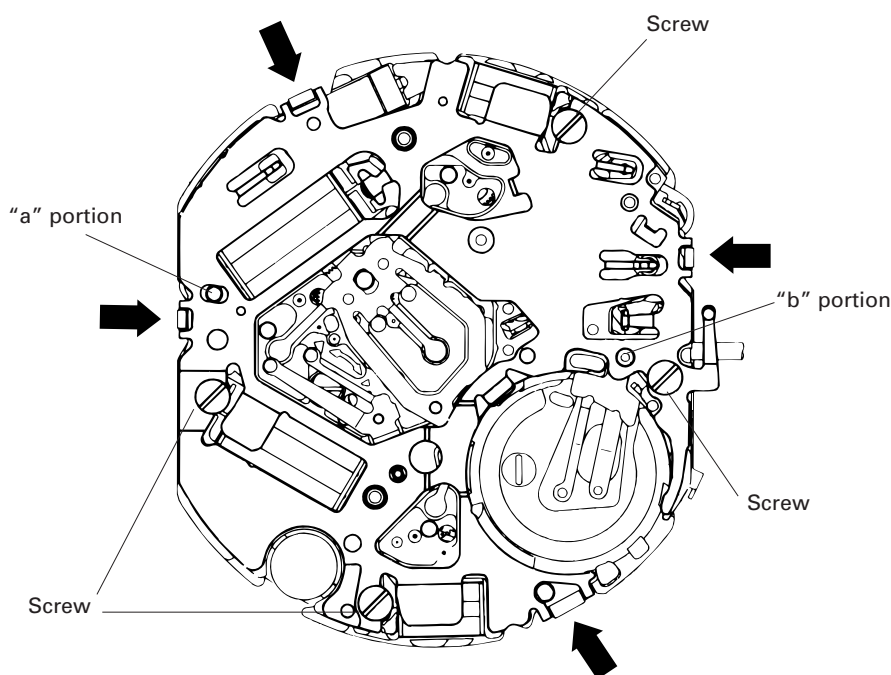

⑭ Friction spring for second counting

• **Setting position**

To set the friction spring for second counting, slip it into the gap under the train wheel bridge.

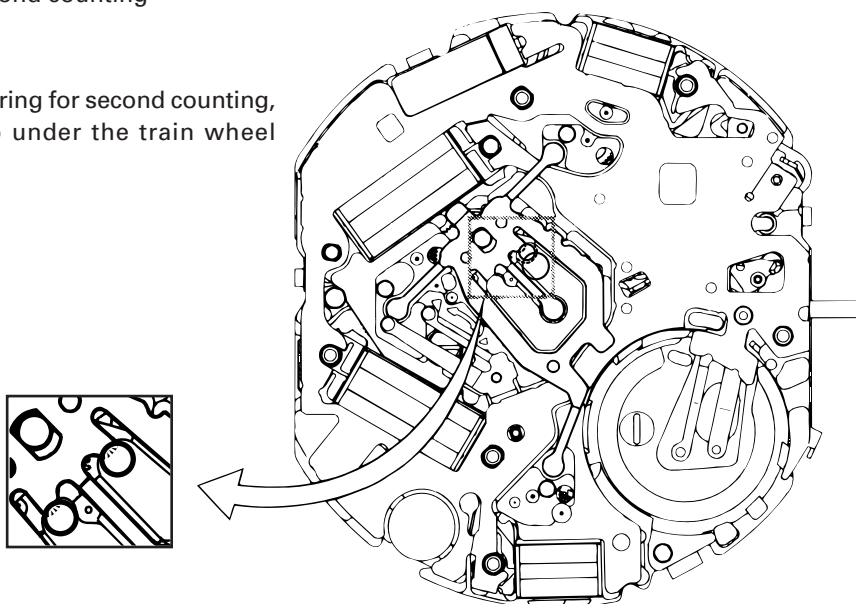

⑮ Circuit block

- **Caution for disassembling**

The circuit block is fixed to the train wheel bridge with the guide pins ("a", "b", "c", "d" and "e" in the illustration shown below). When removing the circuit block from the guide pins, take care not to damage the circuit block.

- **How to install**

Have the guide holes of the circuit block ("a", "b", "c", "d" and "e" portions in the illustration) securely caught by the guide pins of the train wheel bridge and the guide tubes of the main plate.

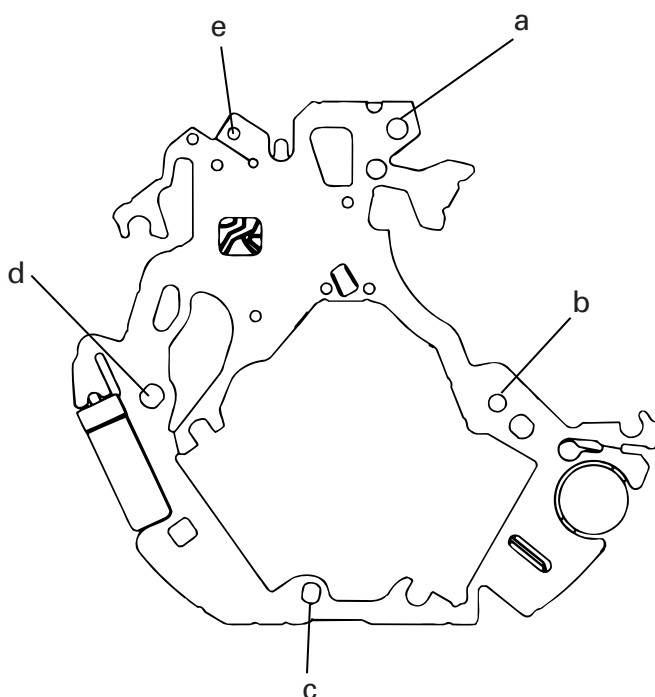

⑱ Pin for train wheel bridge

• **How to remove**



Turn the pin 90 degrees counterclockwise with a screwdriver to loosen it.

• **How to install**

Set the pin in the direction as shown below. Then, turn it 90 degrees clockwise with a screwdriver to fix it.

• **Lubricating**

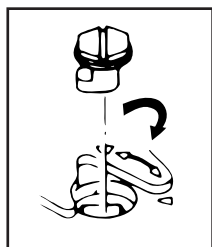

After installing the pin, lubricate the upper pivot of the parts as indicated in the table below.

	AO-3 (or MS-A) 	AO-2 (or MS-F) 
CAL. 7T62A	Minute wheel Small second wheel Minute counting wheel Center wheel for alarm Second counting wheel	Chronograph rotor for second Chronograph rotor for minute Alarm rotor Step rotor
CAL. 7T92A	Minute wheel Small second wheel Second counting wheel (1/20) Second counting wheel	Chronograph rotor for second (1/20) Chronograph rotor for second Chronograph rotor for minute Step rotor
CAL. 7T94A	Minute wheel Small second wheel Minute counting wheel	Chronograph rotor for second Chronograph rotor for minute Step rotor

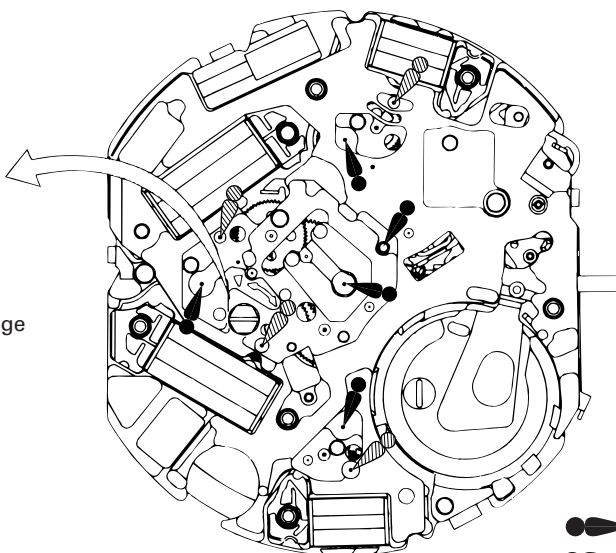

Pin for train wheel bridge



 AO-3 (or MS-A)
 AO-2 (or MS-F)

⑲ Train wheel bridge

• **How to install**

Before installing the train wheel bridge, carefully check the setting positions of the wheels and rotors. Be sure to check that each rotor has a lower pivot attached securely.

If the wheels and rotors are all set in position with the winding stem with crown at the first click, the train wheel bridge can be installed smoothly. There is no need to press down the train wheel bridge.

If the train wheel bridge will not be seated in position smoothly, the other parts must be set in the wrong position. Check their setting positions.

● Wheels and pinions

Notes:

1.

CAL. 7T62A:

Intermediate minute counting wheel and intermediate alarm wheel can be used interchangeably.

CAL. 7T92A:

Intermediate wheel for second counting (1/20) and intermediate minute counting wheel can be used interchangeably.

2. The following rotors for each caliber can be used interchangeably:

CAL. 7T62A

- Chronograph rotor for second (1/5)
- Chronograph rotor for minute
- Alarm rotor
- Step rotor

CAL. 7T92A

- Chronograph rotor for second (1/20)
- Chronograph rotor for second
- Chronograph rotor for minute
- Step rotor

CAL. 7T94A

- Chronograph rotor for second (1/5)
- Chronograph rotor for minute
- Step rotor







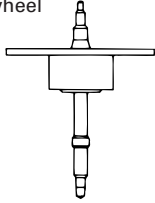
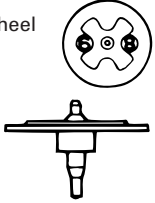

• Setting position

See the illustration on the next page.

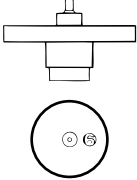
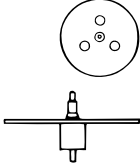
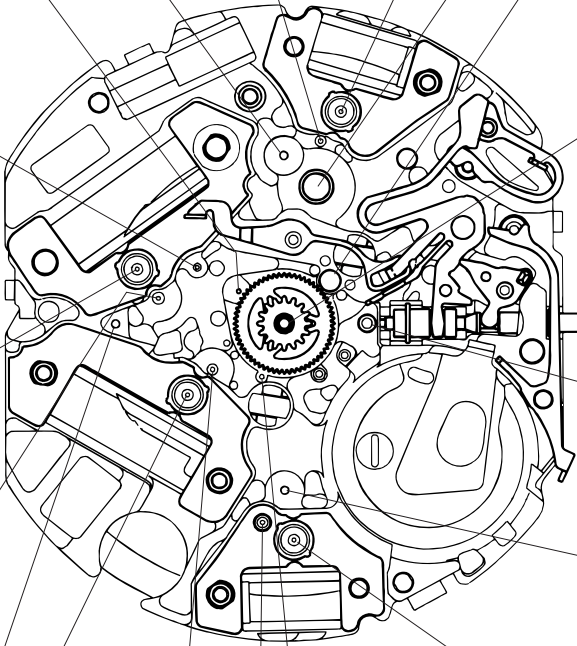
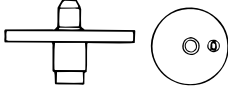
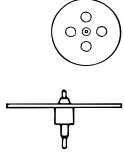
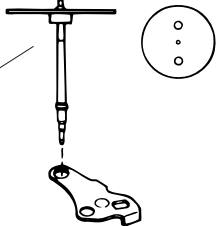
TECHNICAL GUIDE

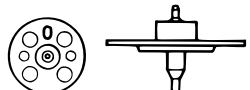
Cal. 7T62A/7T92A/7T94A

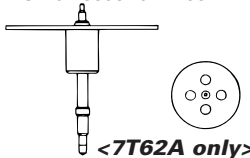
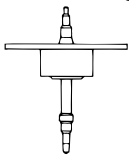

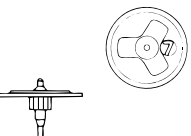
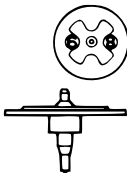
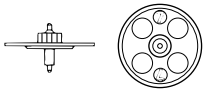



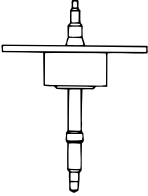
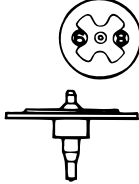

The illustrations refer only to Cal. 7T62A & 7T94A.

<p>31) 0270 582 <7T62A> Center wheel for alarm</p> <p>21a) 0240 582 <7T94A> Small second wheel</p> 	<p>30) 0950 590 <7T62A> Intermediate alarm wheel</p> <p>21b) 0817 508 <7T94A> Intermediate small second wheel</p> 	<p>37) 4146 710 Alarm rotor</p>  <p><7T62A only></p>	<p>32) 0261 582 Minute wheel for alarm</p>  <p><7T62A only></p>		
<p>23) 0231 580 Third wheel & pinion</p> 			<p>27) 0261 580 Minute wheel</p> 		
<p>22) 0241 583 Fourth wheel & pinion</p> 			<p>20) 0888 582 Second counting wheel</p> 		
<p>38) 4146 710 Step rotor</p> 			<p>47) 4283 581 Spacer for center wheel & pinion</p> 		
<p>24) 0701 580 Fifth wheel & pinion</p> 			<p>44) 0281 580 Setting wheel</p> 		
<p>21) 0240 580 Small second wheel</p>  <p><7T62A only></p>			<p>29) 0902 580 Minute counting wheel</p> 		
<p>39) 4146 710 Chronograph rotor for second</p> 			<p>25) 0885 590 First intermediate wheel for second counting</p> 	<p>28) 0950 590 Intermediate minute counting wheel</p> 	<p>26) 0885 591 Second intermediate wheel for second counting</p> 

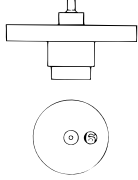
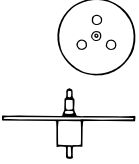
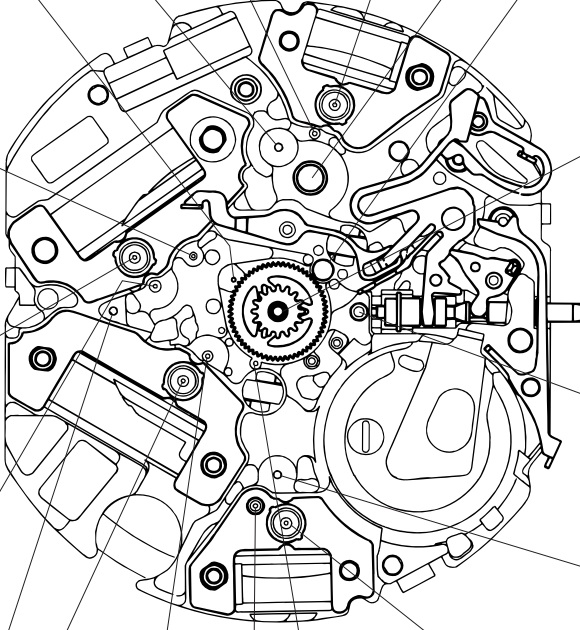
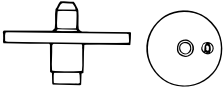
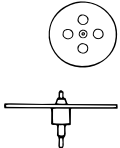
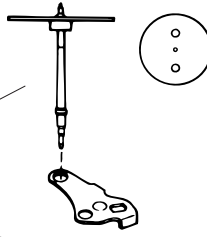
TECHNICAL GUIDE

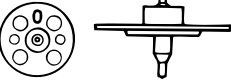
Cal. 7T62A/7T92A/7T94A

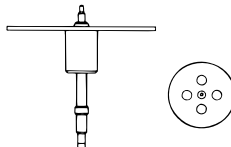
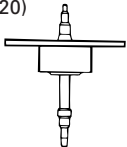
The illustrations refer only to Cal. 7T92A.

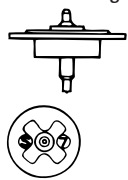
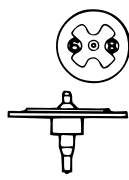
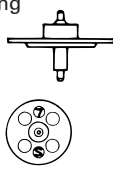
<p>③① 0270 582 Minute counting wheel</p> 	<p>③⑩ 0950 590 Intermediate minute counting wheel</p> 	<p>③⑦ 4146 710 Chronograph rotor for minute</p> 	<p>③② 0261 582 Intermediate wheel for hour counting</p> 		
<p>②③ 0231 580 Third wheel & pinion</p> 			<p>②⑦ 0261 580 Minute wheel</p> 		
<p>②② 0241 583 Fourth wheel & pinion</p> 			<p>②⑩ 0888 582 Second counting wheel</p> 		
<p>③⑧ 4146 710 Step rotor</p> 			<p>④⑦ 4283 581 Spacer for center wheel & pinion</p> 		
<p>②④ 0701 580 Fifth wheel & pinion</p> 			<p>④④ 0281 580 Setting wheel</p> 		
<p>②① 0240 580 Small second wheel</p> 			<p>②⑨ 0902 580 Second counting wheel (1/20)</p> 		
<p>③⑨ 4146 710 Chronograph rotor for second</p> 			<p>②⑤ 0885 594 First intermediate wheel for second counting</p> 	<p>②⑧ 0950 590 Intermediate wheel for second counting (1/20)</p> 	<p>②⑥ 0885 595 Second intermediate wheel for second counting</p> 

• **Setting position and lubricating**

- ④1 Switch lever (A)
- ④2 Setting lever
- ④3 Yoke
- ④9 Train wheel setting lever

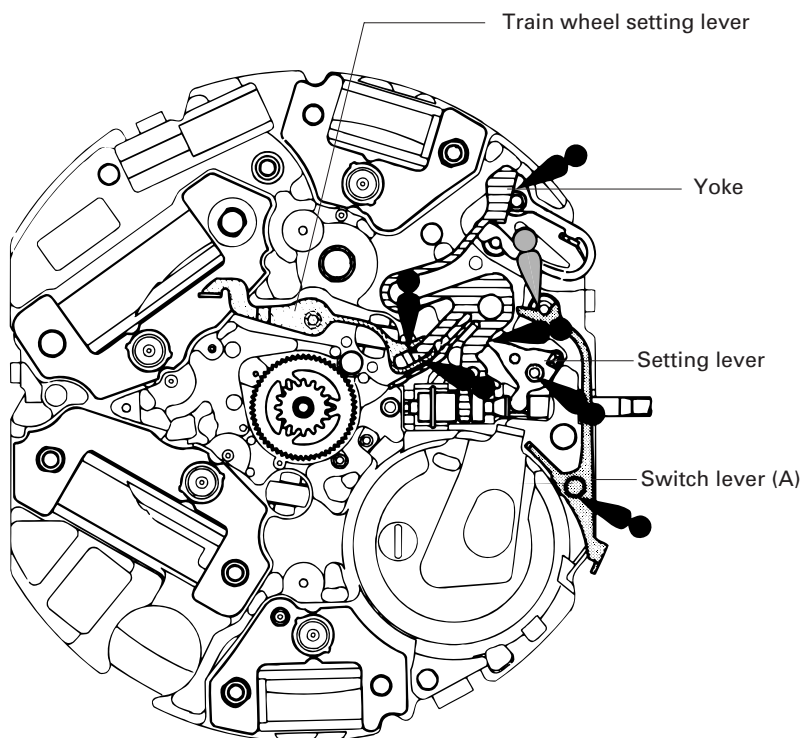
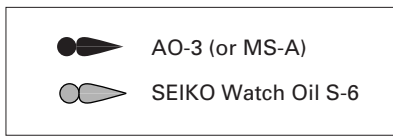

- ④5 Winding stem

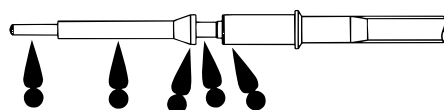



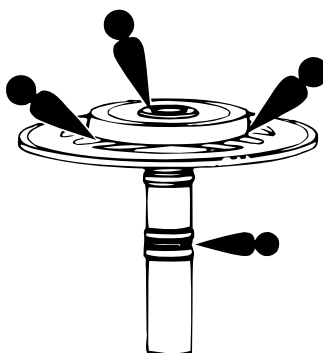

- ④8 Center wheel and pinion

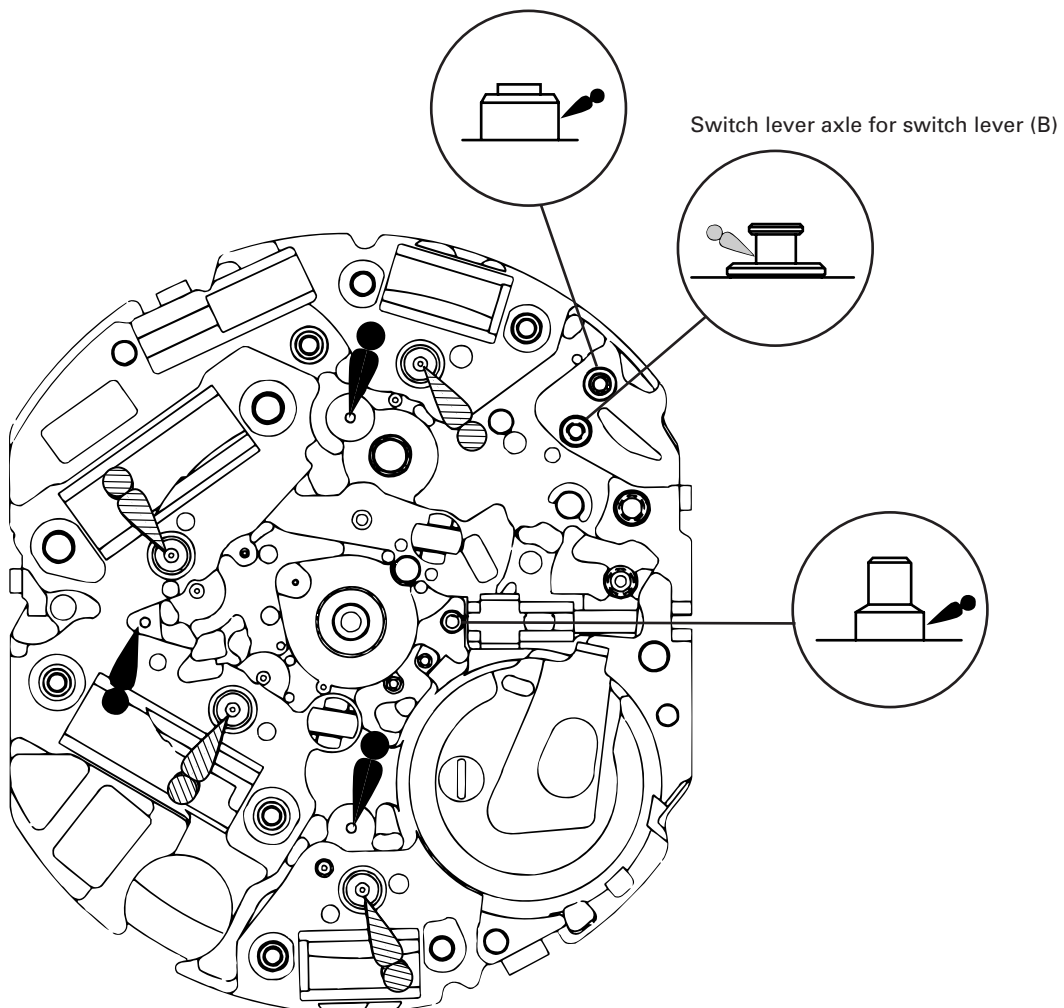

55 Main plate

• Lubricating



-  AO-3 (or MS-A)
-  AO-2 (or MS-F)
-  SEIKO Watch Oil S-6

IV. VALUE CHECKING

● Coil block resistance

Coil block (A)	1.70 K Ω ~ 2.60 K Ω
Coil block for chronograph second	1.70 K Ω ~ 2.60 K Ω
Coil block for chronograph minute (Cal. 7T62A) Coil block for second counting (1/20) (Cal. 7T92A)	1.80 K Ω ~ 2.40 K Ω
Coil block for alarm (Cal. 7T62A) Coil block for chronograph (Cal. 7T92A)	1.80 K Ω ~ 2.40 K Ω

● Upconverter coil resistance : 150 Ω ~ 180 Ω

● Current consumption

For the whole movement	Less than 1.10 μ A (with 1.55 V supplied from a battery) (when the stopwatch is not used)
For the circuit block alone	Less than 0.20 μ A (with 1.55 V supplied from a battery)

When measuring the current consumption with SEIKO Multi-Tester S-860, select the measurement range as follows:

For the whole movement	Use the range of 40 μ A of SUPPLY V (= 1.55 V) & GATE TIME (2 S)
For the circuit block alone	Use the range of 4 μ A of SUPPLY V (= 1.55 V) & GATE TIME (2 S)

V. FUNCTION CHECKING

● TIME SETTING AND STOPWATCH HAND POSITION ADJUSTMENT

Follow the procedure in "II. NECESSARY PROCEDURE AFTER BATTERY CHANGE" to set the time hands and reset the stopwatch hands to the "0" position.

● STOPWATCH FUNCTION

- * Before checking the stopwatch function, reset the stopwatch hands to the "0" position following the procedure in "II. NECESSARY PROCEDURE AFTER BATTERY CHANGE."
- * Check that the crown is at the normal position. If not, the stopwatch operation cannot be made.

1. Checking for Standard Measurement/Accumulated Elapsed Time Measurement

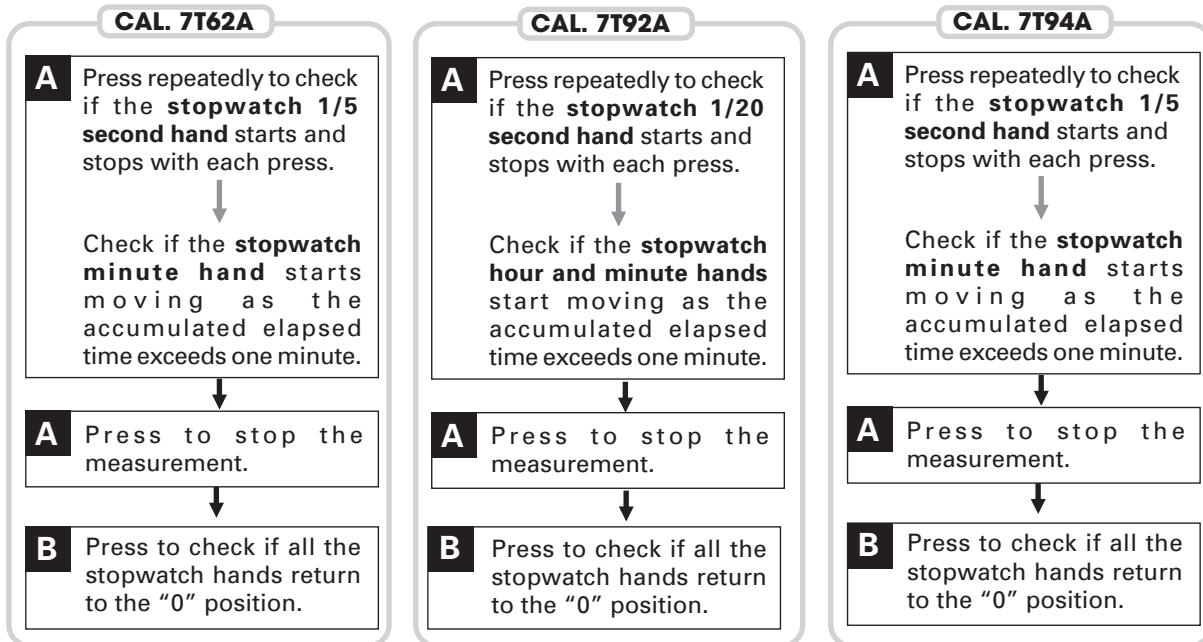

2. Checking for Split Time Measurement

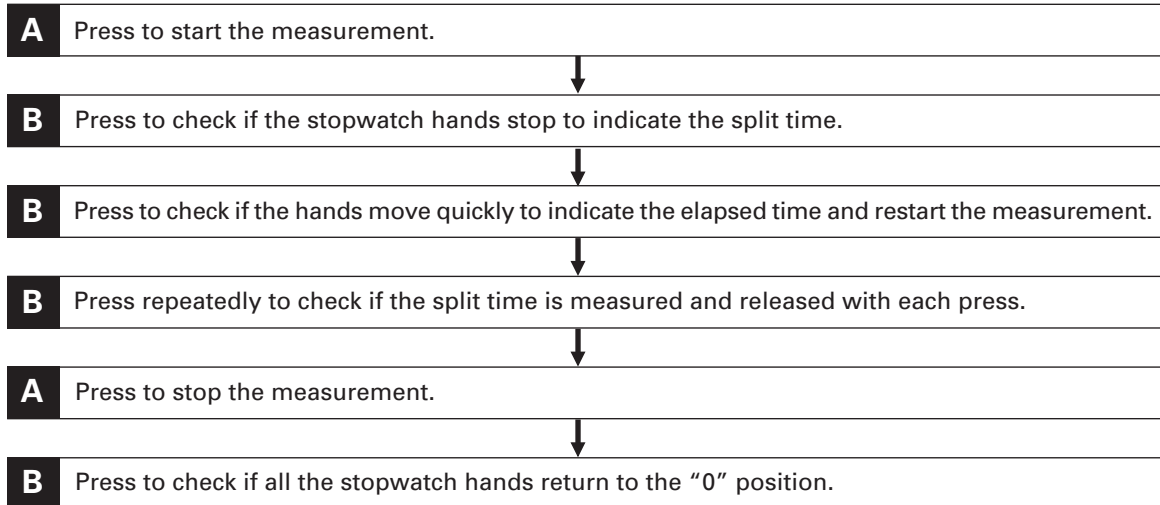

Note for the stopwatch 1/20 second hand for Cal. 7T92A:

* After the stopwatch is started, the stopwatch 1/20-second hand automatically stops and stays at the "0" position if the measurement exceeds 10 minutes. When the measurement is stopped or split time is measured, it moves to indicate the elapsed 1/20 seconds.

Also, after the stopwatch is restarted or split time is released, the stopwatch 1/20-second hand automatically stops and stays at the "0" position if the measurement exceeds another 10 minutes.

● ALARM FUNCTION (Only for Cal. 7T62A)

- Before checking the alarm function, set the time and alarm hands to the current time following the procedure in "II. NECESSARY PROCEDURE AFTER BATTERY CHANGE."

❖ To Set the Alarm Time

CROWN Pull out to the 1st click.



B Press repeatedly to set the alarm hands to the desired alarm time.

- * With each press, they move by one minute. They move quickly if the button is kept pressed. They stop when they reach the current time. Release and press the button, and the hands will start moving again.
- * The single-time alarm cannot be set for a time more than 12 hours ahead of the current time.



CROWN Push back in to the normal position.

❖ To Readjust the Designated Alarm Time

CROWN Pull out to the 1st click.



B Press repeatedly to set the alarm hands to the desired alarm time.



CROWN Push back in to the normal position.

❖ To Cancel the Alarm

CROWN Pull out to the 1st click.



B Press repeatedly to set the alarm hands to the current time.



CROWN Push back in to the normal position.

- * At the designated alarm time, the alarm rings for 20 seconds and stops. To stop it manually, press button "A" or "B".
- * After the alarm rings, the alarm minute hand starts moving at one-minute intervals, then the alarm hands indicate the current time.

VI. TROUBLESHOOTING

	Symptom	Possible causes	Solutions
Movement	The watch stops operating.	The battery has been depleted.	Measure the battery voltage. Replace the battery with a new one.
		The hour wheel and the pinion of the minute wheel are not properly engaged. (Or the teeth of the hour wheel and/or minute wheel has been broken.)	Check the relevant parts, and replace the damaged parts with new ones.
		The hooking portions of the circuit block cover are not properly engaged, resulting in poor conductivity.	Securely attach the hooks of the circuit block cover to the main plate.
		The coil is broken.	Measure the coil block resistance. Replace the coil with a new one.
		One or more wheels have been contaminated with dirt, dust or other particles. An excessive amount of oil in the movement has caused adhesive forces among the parts. (wringing)	Remove dirt or dust and clean the contaminated wheels. Be careful so as not to damage the teeth of the plastic parts while cleaning.
	The current consumption for the whole movement exceeds the standard value.	Dirt, dust or foreign particles are adhered to the movement.	Remove dirt, dust or foreign particles and clean the movement.
		The driving pulse is generated in order to compensate the excessive load applied to the wheels. (The oil is deteriorated, leaked or ran out.)	If the current consumption for the circuit block alone is within the standard value range, overhaul and clean the movement parts, and then make the measurement again.
	The current consumption for the circuit block alone exceeds the standard value.	The light from outside the movement is affecting the measurement.	Shut out the light, and make the measurement again.
		There is a defect in the IC (integrated circuit).	Replace the circuit block with a new one.
	The date dial shows an abnormal movement.	The date dial has become improperly engaged with the date driving wheel or disengaged from the date driving wheel.	Check the rotation and engagement of the date dial. Bend the date dial downward to adjust the clearance. Or replace the date dial with a new one.
The date dial does not move.			
The date does not change.	The date jumper has disengaged.		

	Symptom	Possible causes	Solutions
Stopwatch/ Alarm	One or more hands of the stopwatch or alarm have stopped moving or show an abnormal movement.	The relevant coil is broken.	Measure the coil block resistance. Replace the coil with a new one if necessary.
		The excessive load is being applied to the chronograph wheels due to dust or foreign particles adhered to them or oil starvation.	Clean the relevant parts and lubricate with an adequate amount of oil.
	The step motor shows an abnormal movement.	There is a crack on the circuit block switch pattern.	Replace the circuit block with a new one.
		The step motor has been diformed.	Replace the stator with a new one.
	The buttons do not operate normally.	The amount of oil around the buttons is insufficient.	Clean the buttons and lubricate appropriately.
		The circuit block pattern has been broken or bended.	Adjust the circuit block pattern or replace the circuit block with a new one.
	The alarm does not sound. (For 7T62A only)	The upconverter coil is broken.	Replace the circuit block with a new one.
	The alarm sound is too small. (For 7T62A only)	The Piezoelectric element is broken or out of alignment.	Remount the piezoelectric element or replace it with a new one.
Exterior parts	The crown falls off.	The winding stem is not securely installed. (The setting lever and yoke are disengaged.)	Check the main plate, winding stem, setting lever and yoke. Replace the defective parts with new ones.
	The current consumption exceeds the standard value.	The excessive load is being applied due to frictions among the hour, minute and chronograph hands.	Adjust or remount the relevant hands.
	Small amount of water/blur inside of the glass persists.	Water resistance is deteriorated. The watch has been subjected to water pressure that exceeds the guaranteed degree.	Investigate the causes to take necessary measures, while cleaning inside of the watch.